

www.americanprod.com Email: bids@americanprod.com

Phone: 813-925-0144 Fax: 813-925-1414

**Storefront With
Horizontals**

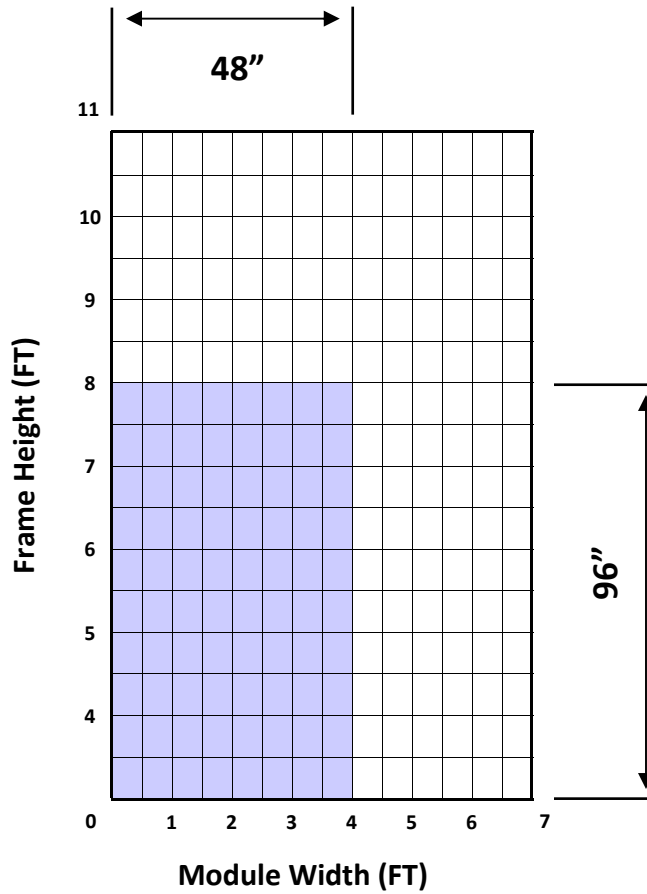

**Storefront Without
Horizontals**

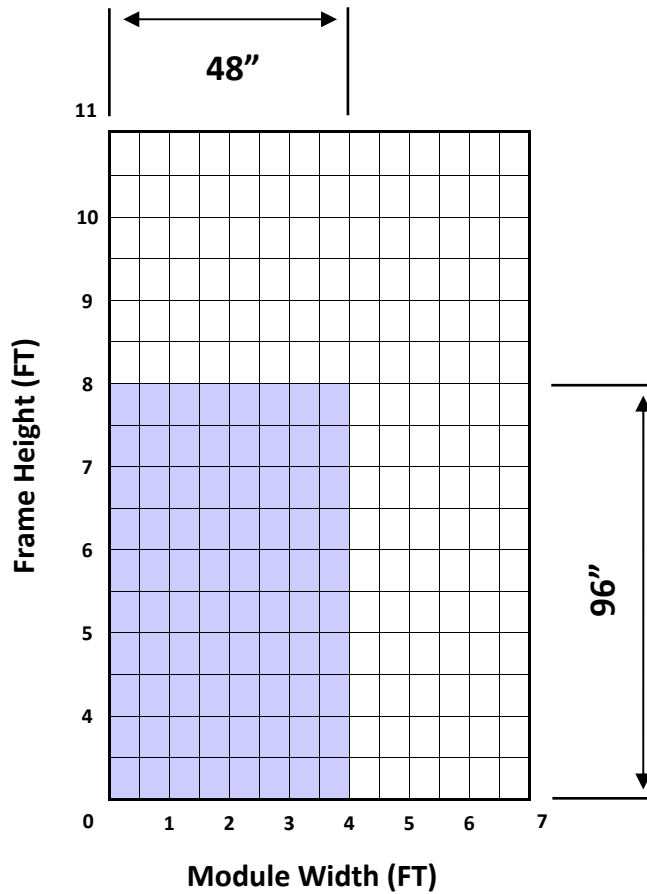

The Design Pressure is less than or equal to 50 PSF Positive and 50 PSF Negative.



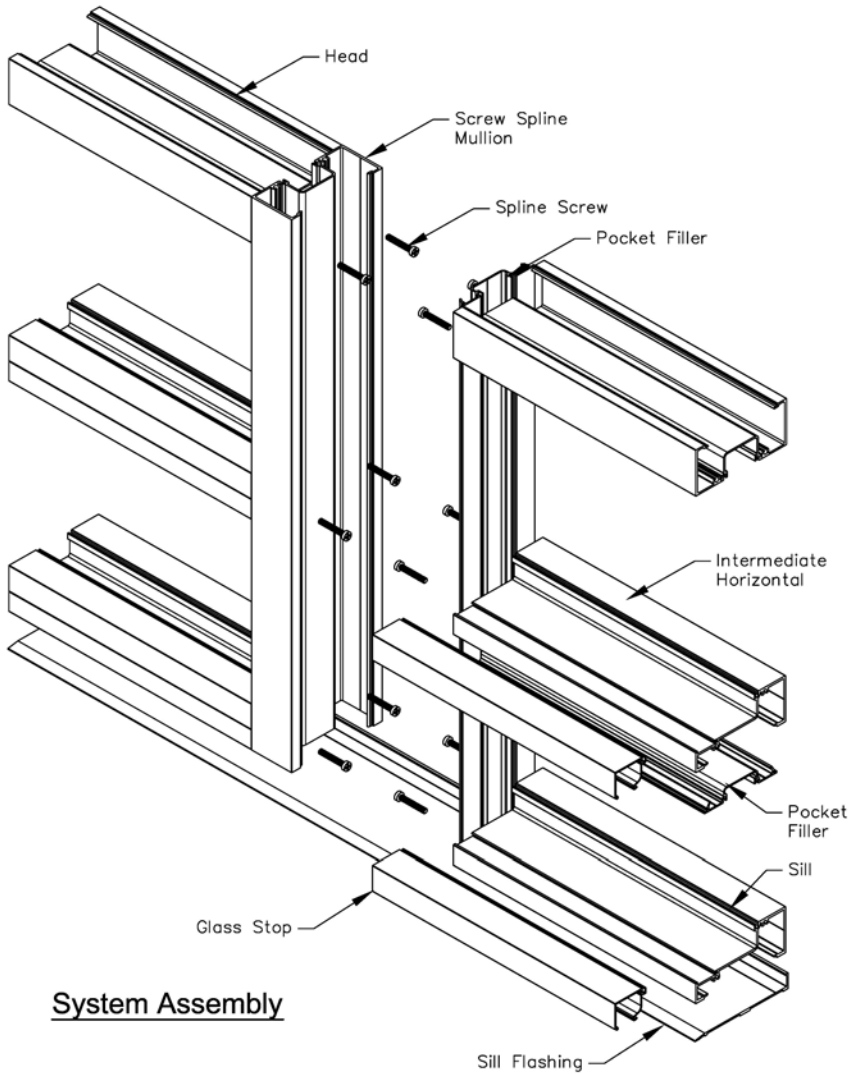

System Assembly

**1" Screw Spline
Flush Glaze**

Stops Up

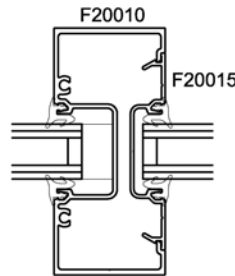

Screw Spline Vertical Mullion Section

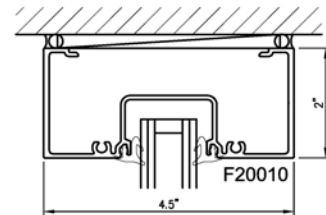

Head/Jamb Section

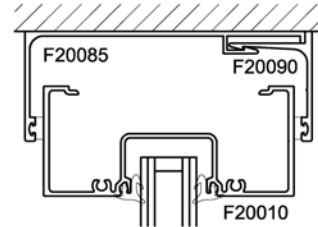

Head Receptor Section

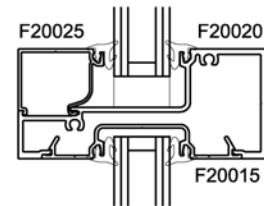

Intermediate Horizontal Section

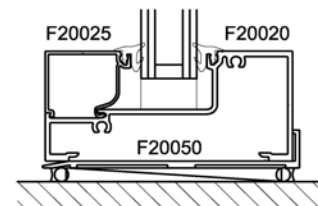

Sill Section

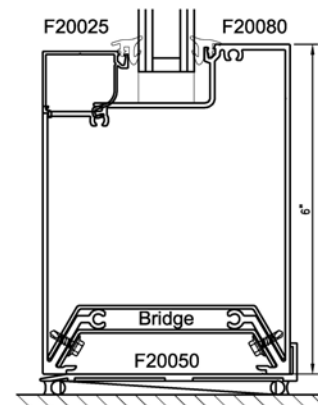

6" Sill Section

www.americanprod.com Email: bids@americanprod.com

Phone: 813-925-0144

Fax: 813-925-1414

www.americanprod.com Email: bids@americanprod.com

Fax: 813-925-1414

Phone: 813-925-0144

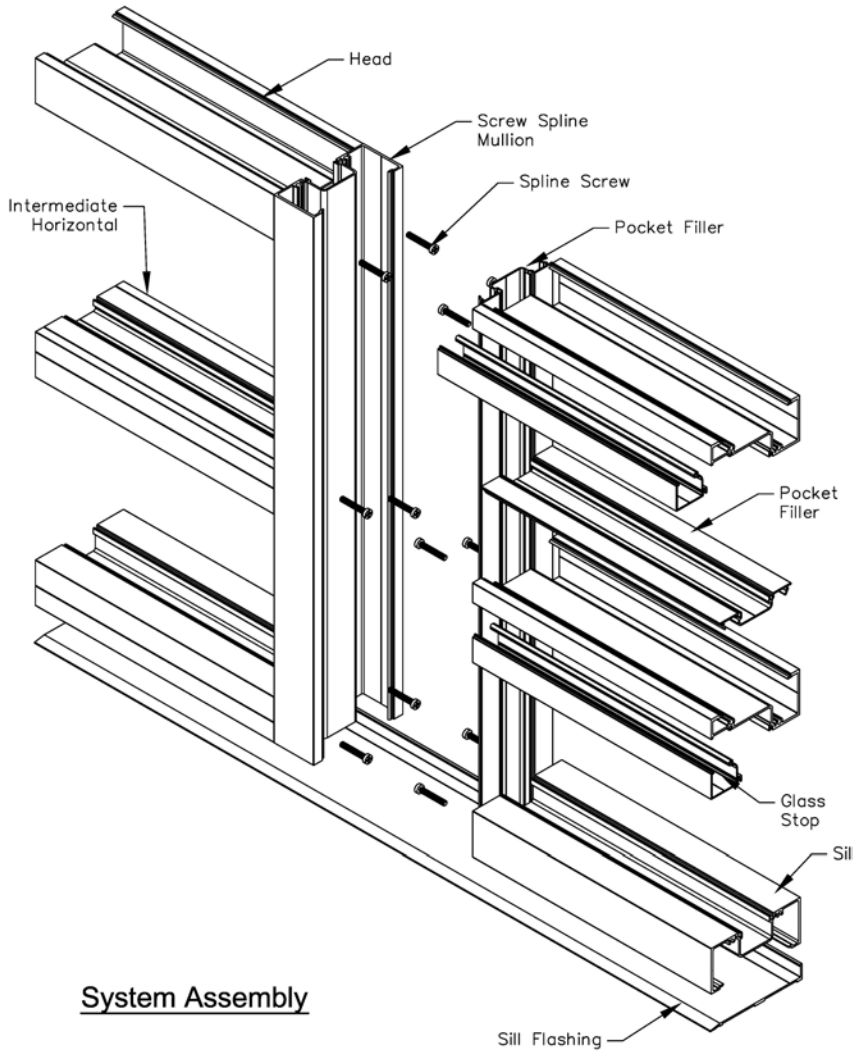

System Assembly

**1" Screw Spline
Flush Glaze
Stops Down**

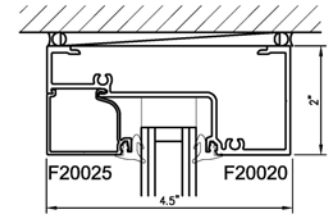

Head/Jamb Section

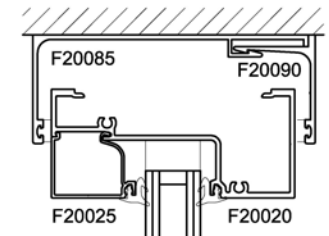

Head Receptor Section

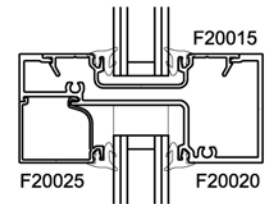

**Intermediate
Horizontal Section**

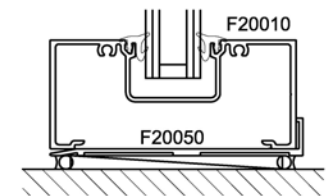

Sill Section

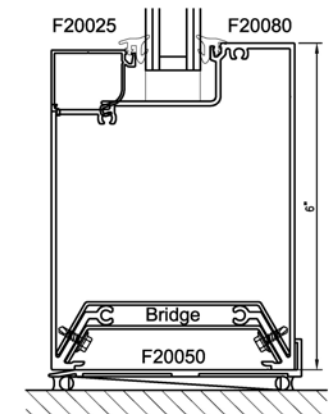

6" Sill Section

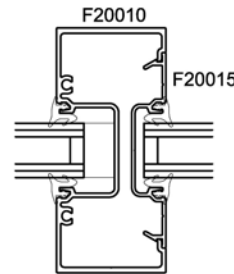

**Screw Spline Vertical
Mullion Section**



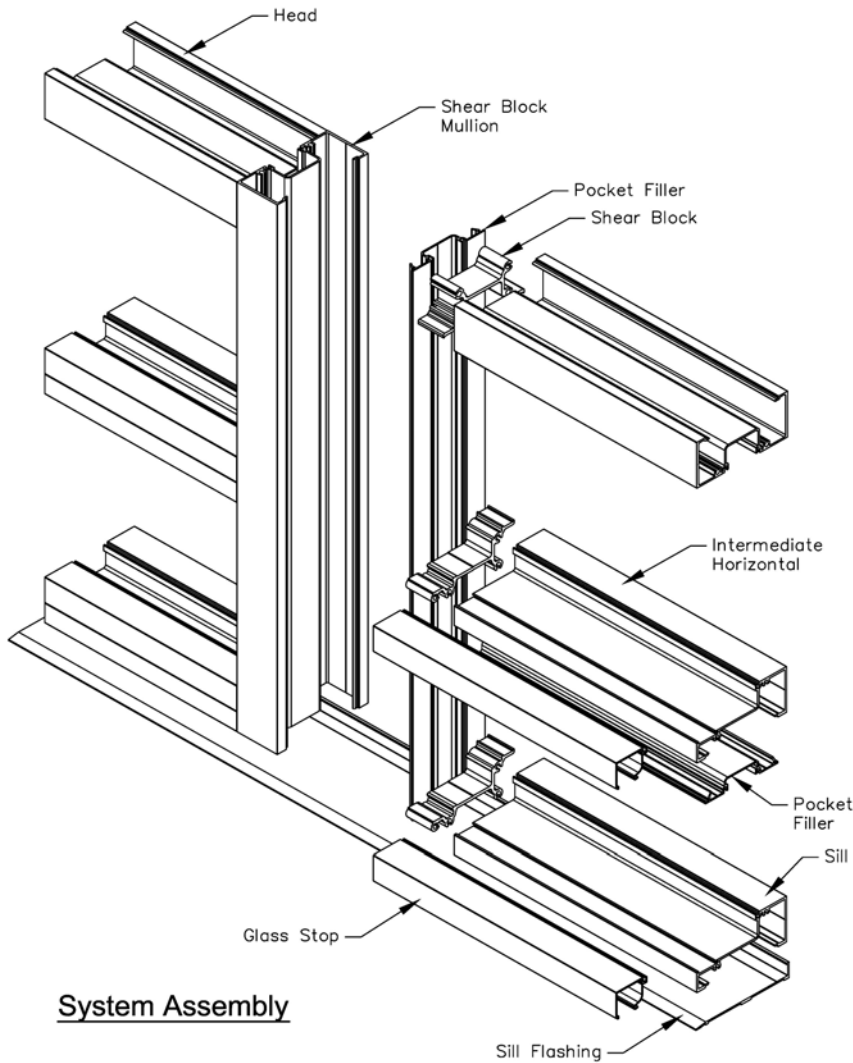

System Assembly

**1" Shear Block
 Flush Glaze
 Stops Up**

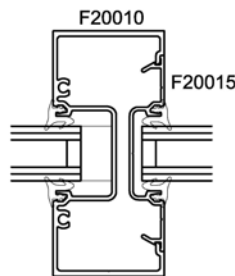

**Screw Spline Vertical
 Mullion Section**

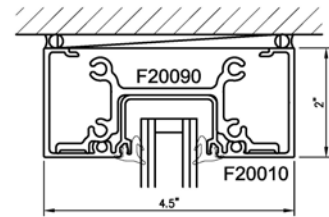

Head/Jamb Section

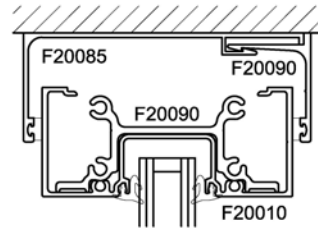

Head Receptor Section

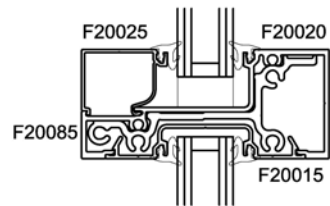

**Intermediate
 Horizontal Section**

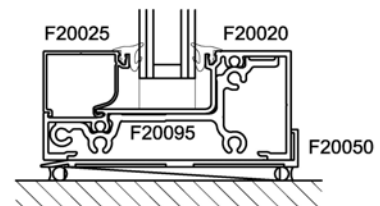

Sill Section

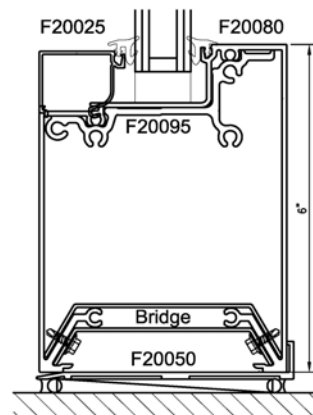

6" Sill Section

www.americanprod.com Email: bids@americanprod.com

Phone: 813-925-0144

Fax: 813-925-1414



www.americanprod.com Email: bids@americanprod.com

Phone: 813-925-1414 Fax: 813-925-1414

Phone: 813-925-0144

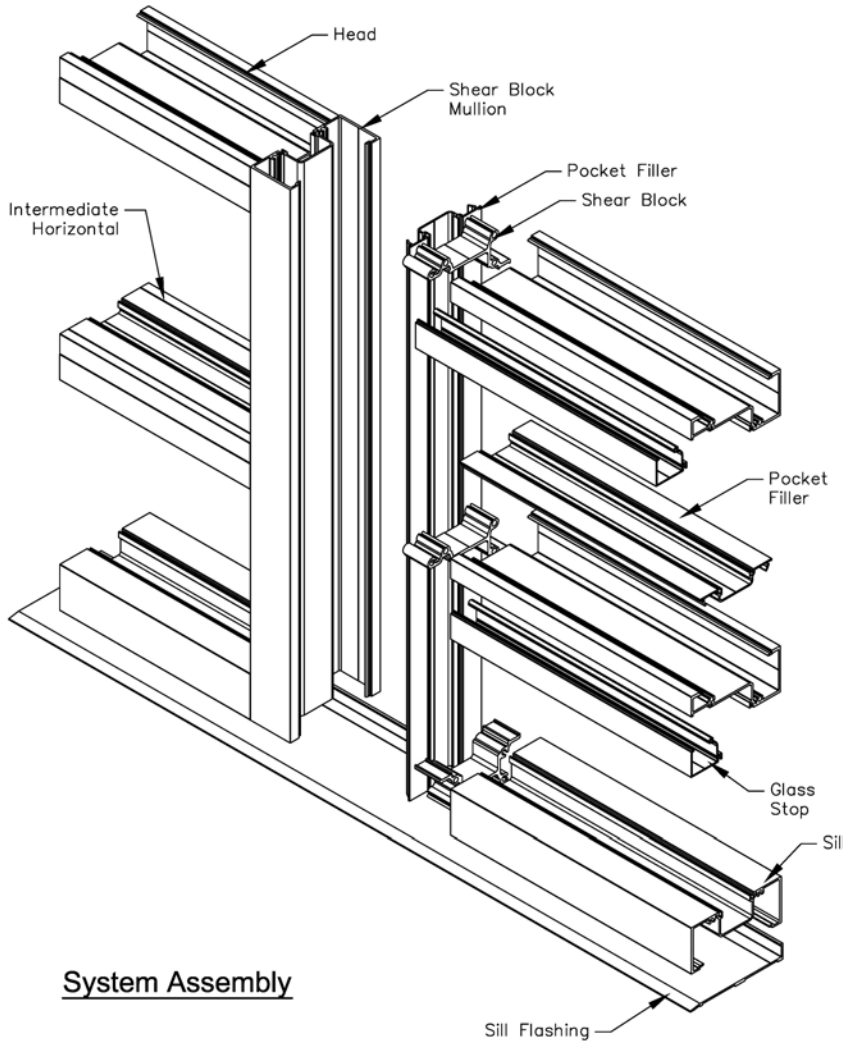

System Assembly

1" Shear Block
Flush Glaze
Stops Down

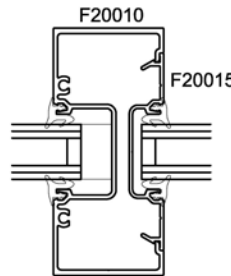

Screw Spline Vertical Mullion Section

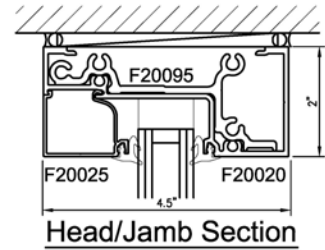

Head/Jamb Section

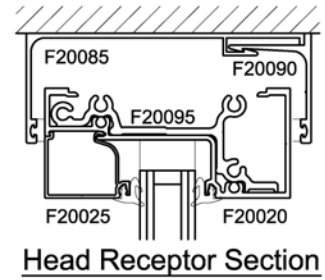

Head Receptor Section

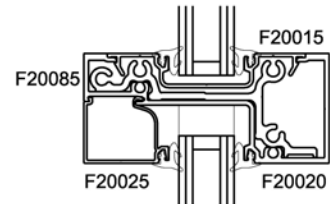

Intermediate Horizontal Section

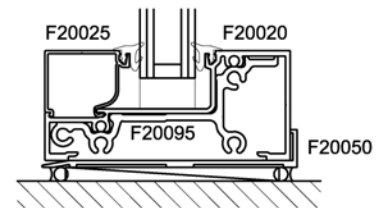



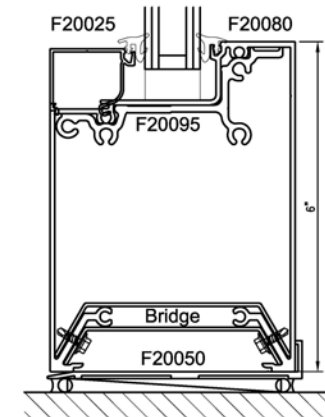

Sill Section





6" Sill Section

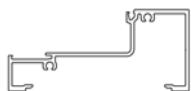

FRAMING MEMBERS

DESCRIPTION	PART NUMBER	FOOT / UNIT	UNITS / PACKAGE	FINISH	LIST PRICE / UNIT
 Head / Jamb	F20010	24'	4	Clear	\$175.00
				Bronze	\$219.13
				2-Coat Kynar	\$198.00
				Powder Coat	\$212.18
 Stop	F20025	24'	4	Clear	\$40.54
				Bronze	\$65.00
				2-Coat Kynar	\$59.81
				Powder Coat	\$60.14
 Open Back Sill / Horizontal	F20020	24'	4	Clear	\$140.06
				Bronze	\$185.14
				2-Coat Kynar	\$195.00
				Powder Coat	\$173.40
 Flat Perimeter Filler	F20045	24'	4	Clear	\$75.00
				Bronze	\$62.64
				2-Coat Kynar	\$66.86
				Powder Coat	\$74.23
 Shallow Pocket Filler	F20015	24'	4	Clear	\$80.00
				Bronze	\$84.00
				2-Coat Kynar	\$85.01
				Powder Coat	\$109.26
 Deep Pocket Filler	F20016	24'	4	Clear	Quote
				Bronze	Quote
				2-Coat Kynar	Quote
				Powder Coat	Quote
 Sill Flashing	F20050	24'	4	Clear	\$95.00
				Bronze	\$105.00
				2-Coat Kynar	\$110.00
				Powder Coat	\$104.75

CORNERS

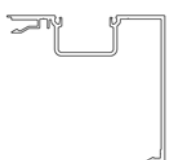
 4-1/2" No Pocket Corner Half	F20075	24'	4	Clear	\$157.64
				Bronze	\$205.16
				2-Coat Kynar	\$204.23
				Powder Coat	\$258.44
 4-1/2" Right Corner Half	F20065	24'	4	Clear	\$189.87
				Bronze	\$247.52
				2-Coat Kynar	\$245.62
				Powder Coat	\$268.27
 4-1/2" Left Corner Half	F20060	24'	4	Clear	\$192.42
				Bronze	\$250.99
				2-Coat Kynar	\$249.06
				Powder Coat	\$270.82

www.americanprod.com Email: bids@americanprod.com

Phone: 813-925-0144 Fax: 813-925-1414





www.americanprod.com Email: bids@americanprod.com

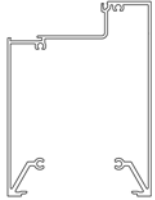

Fax: 813-925-1414

Phone: 813-925-0144



TALL SIDELITE BASE

DESCRIPTION	PART NUMBER	FOOT / UNIT	UNITS / PACKAGE	FINISH	LIST PRICE / UNIT
 <p>6" Sill / Horizontal</p>	F20080	24'	4	Clear	\$480.88
				Bronze	\$565.00
				2-Coat Kynar	\$585.00
				Powder Coat	\$664.02
 <p>Bridge (For Bay Over 48")</p>	F20080ULB	12'	4	Clear	\$201.60

RECEPTORS

 <p>Head Receptor With Gasket</p>	F20085	24'	4	Clear	Quote
				Bronze	Quote
				2-Coat Kynar	Quote
				Powder Coat	Quote
 <p>Head Receptor Face With Gasket</p>	F20090	24'	4	Clear	Quote
				Bronze	Quote
				2-Coat Kynar	Quote
				Powder Coat	Quote



GLAZING ADAPTOR

 <p>1/2" Glazing Adaptor</p>	F50005	24'	4	Clear	\$17.58
				Bronze	\$31.92
				2-Coat Kynar	\$28.56
				Powder Coat	\$39.98
 <p>1/4" Glazing Adaptor</p>	F50010	24'	4	Clear	Quote
				Bronze	Quote
				2-Coat Kynar	Quote
				Powder Coat	Quote





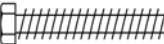

GASKET

 <p>Standard Vinyl</p>	FAPI-129	250'	1	Black	\$43.40
 <p>Heavy Vinyl</p>	FAPI-177	250'	1	Black	\$50.76
 <p>Light Vinyl</p>	FAPI-176	250'	1	Black	\$77.00

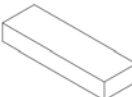
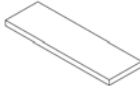
FASTENERS

DESCRIPTION	PART NUMBER	FOOT / UNIT	UNITS / PACKAGE	FINISH	LIST PRICE / UNIT
 Screw Spline Screws #12 x 1-1/4"	FA0001	Ea	100		\$.06
 Shear Block Screws #10 x 1-19/32"	FA0002	Ea	100		\$.11
 Shear Block Screws #10 x 9/16" Flat Head	FA0003	Ea	100		\$.10

ACCESSORIES

 1" Setting Block - 5/8" x 1-1/4" x 4"	G32012	Ea	1		\$.70
 1" Setting Block - 3/16" x 1-1/4" x 4"	G32016	Ea	1		\$.45
 Shear Block Sill / Intermediate	FA01868	24'	1	Mill	\$68.32
 Shear Block Head / Jamb	FA01848	24'	1	Mill	\$75.38
 4" Flat Filler	F20045T-4	4"	4	Clear	\$2.14
				Bronze	\$1.79
				2-Coat Kynar	\$1.91
				Powder Coat	\$1.93
 Water Diverter	F20100	Ea	1		\$.60
 Steel Reinforcement	F20105	24'	1		Quote

www.americanprod.com Email: bids@americanprod.com

Phone: 813-925-0144 Fax: 813-925-1414

GLAZING GASKET CHART

Infill	Vinyl	Adaptor
1-1/8"	FAPI-176	N/A
1"	FAPI-176	N/A
7/8"	FAPI-129	N/A
3/4"	FAPI-177	N/A
5/8"	FAPI-176	F50005
1/2"	FAPI-129	F50005
3/8"	FAPI-177	F50005
1/4"	FAPI-176	F50010
1/8"	FAPI-129	F50010

www.americanprod.com Email: bids@americanprod.com

Phone: 813-925-0144 Fax: 813-925-1414



NOTES



www.americanprod.com Email: bids@americanprod.com

Phone: 813-925-0144 Fax: 813-925-1414

**Storefront With
Horizontals**

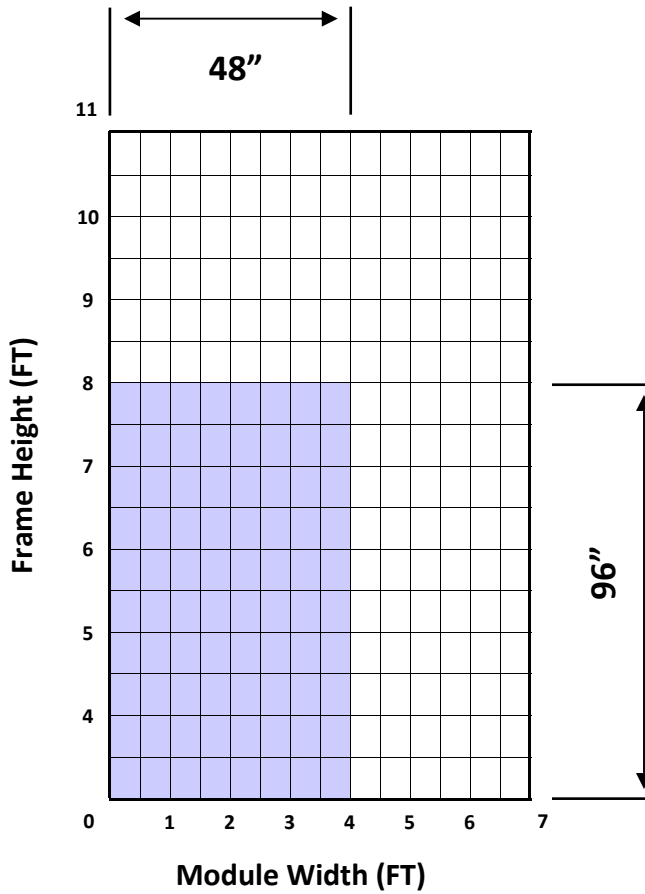

**Storefront Without
Horizontals**

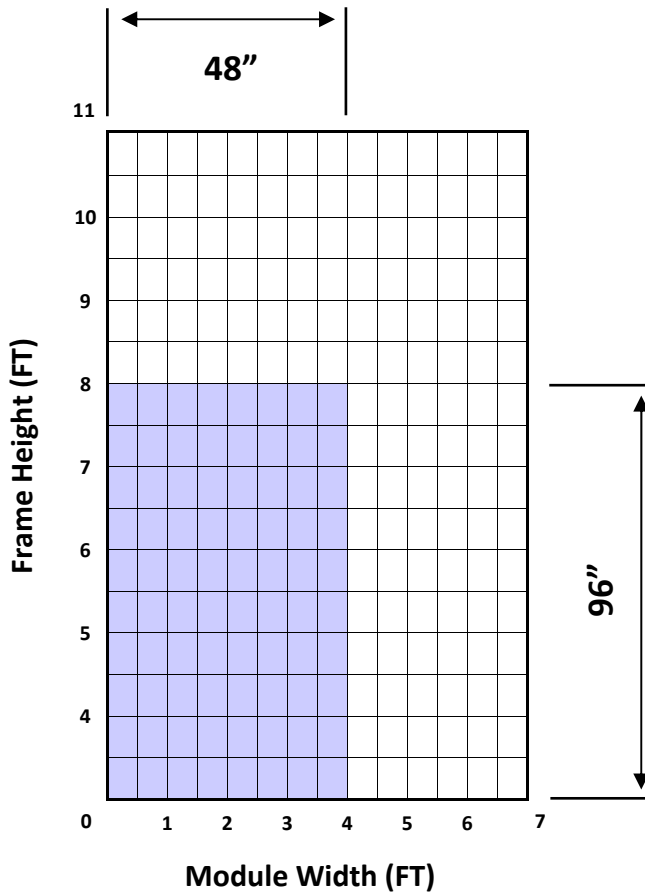

The Design Pressure is less than or equal to 45 PSF Positive and 45 PSF Negative.



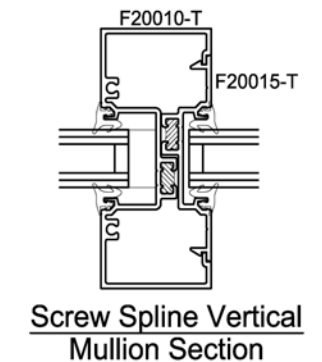
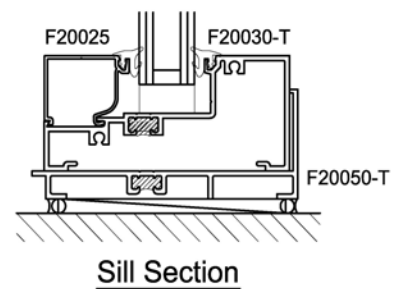
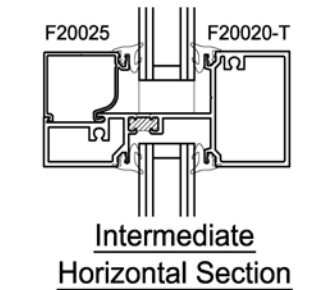
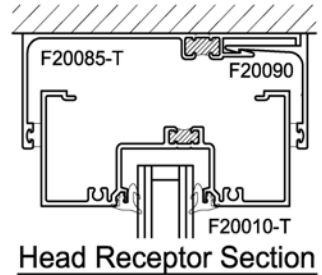
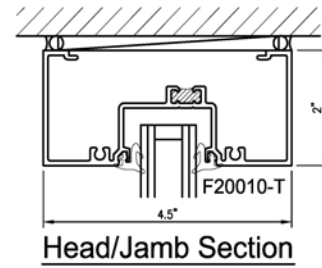
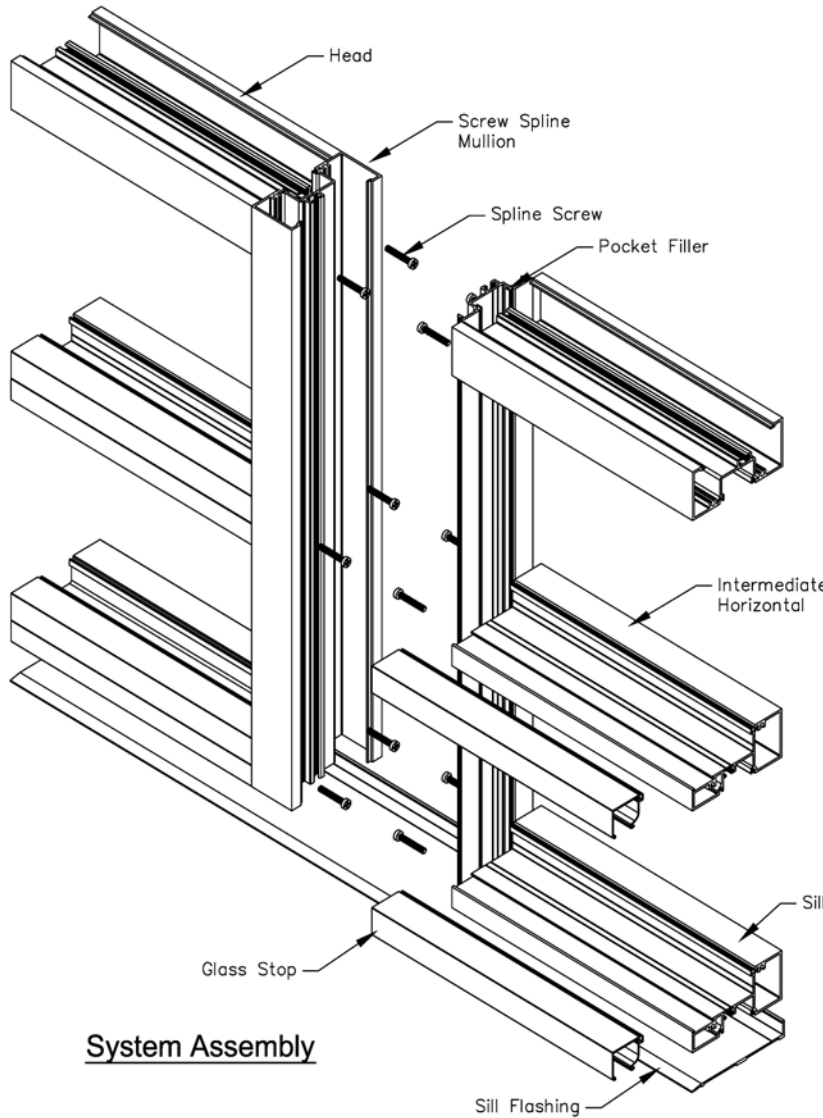

**1" Thermal Screw Spline
Flush Glaze
Stops Up**

www.americanprod.com Email: bids@americanprod.com

Phone: 813-925-0144

Fax: 813-925-1414

www.americanprod.com Email: bids@americanprod.com





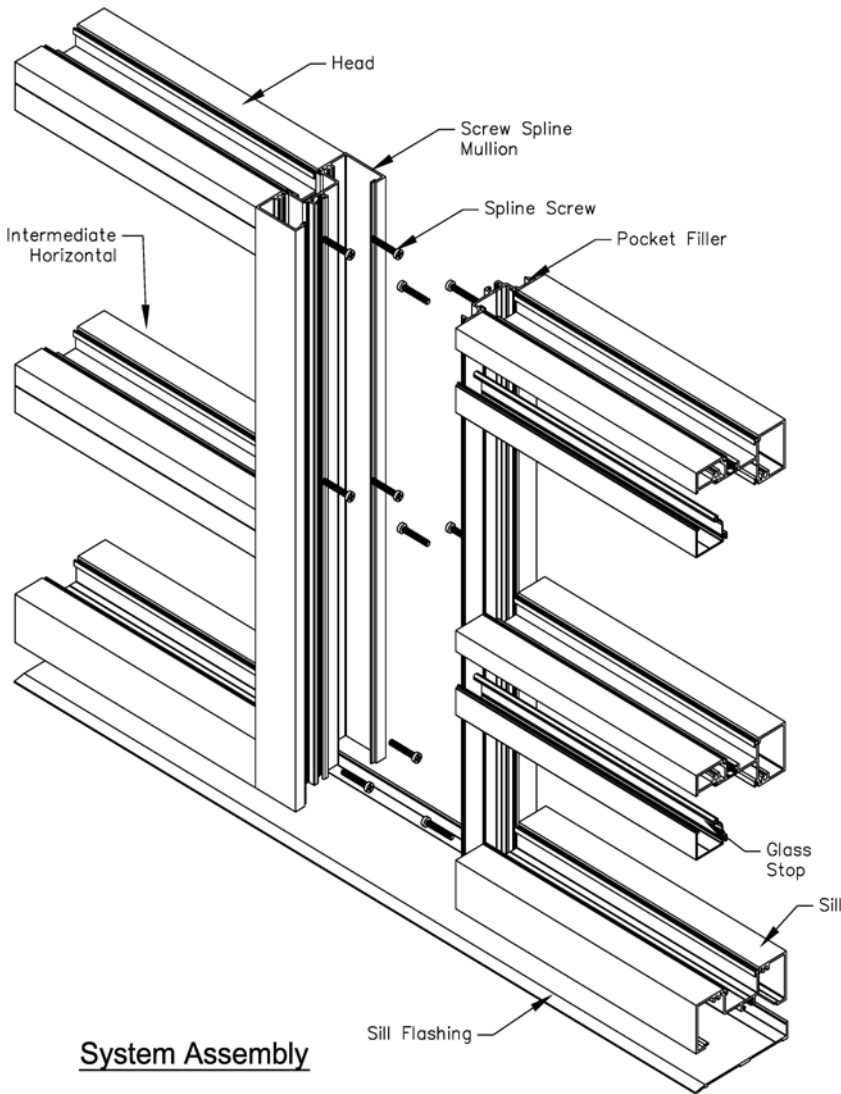

Fax: 813-925-1414

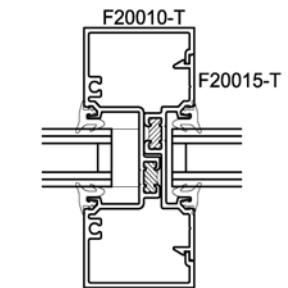
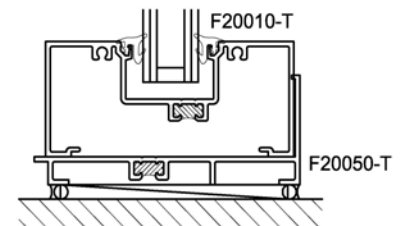
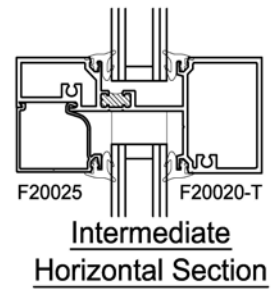
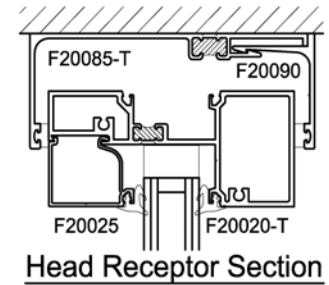
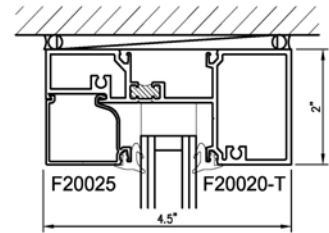
Phone: 813-925-0144

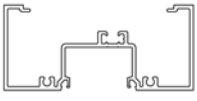

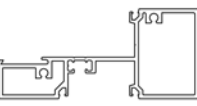
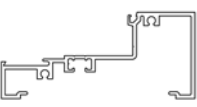
1" Thermal Screw Spline
Flush Glaze
Stops Down

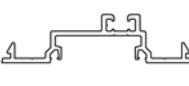

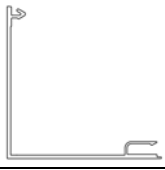
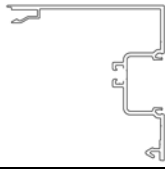
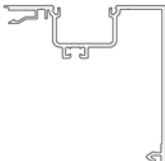
FRAMING MEMBERS					
DESCRIPTION	PART NUMBER	FOOT / UNIT	UNITS / PACKAGE	FINISH	LIST PRICE / UNIT
 Head / Jamb	F20010-T	24'	4	Clear	\$256.24
				Bronze	\$283.54
				2-Coat Kynar	\$314.32
				Powder Coat	N/A
 Stop	F20025-T	24'	4	Clear	\$65.38
				Bronze	\$75.38
				2-Coat Kynar	\$105.64
				Powder Coat	N/A
 Closed Back Sill / Horizontal	F20020-T	24'	4	Clear	\$247.21
				Bronze	\$317.58
				2-Coat Kynar	\$328.93
				Powder Coat	N/A
 Open Back Sill / Horizontal	F20030-T	24'	4	Clear	\$212.13
				Bronze	\$283.03
				2-Coat Kynar	\$262.38
				Powder Coat	N/A
 Sill Flashing	F20050-T	24'	4	Clear	\$171.16
				Bronze	\$190.93
				2-Coat Kynar	\$191.07
				Powder Coat	N/A
 Pocket Filler	F20015-T	24'	4	Clear	\$129.08
				Bronze	\$143.67
				2-Coat Kynar	\$123.59
				Powder Coat	N/A
 Flat Perimeter Filler (Non-Thermal)	F20045T	24'	4	Clear	\$124.06
				Bronze	\$143.67
				2-Coat Kynar	\$123.59
				Powder Coat	N/A
CORNERS					
 4-1/2" No Pocket Corner Half (Non-Thermal)	F20075-T	24'	4	Clear	\$198.27
				Bronze	\$208.18
				2-Coat Kynar	\$257.68
				Powder Coat	N/A
 4-1/2" Right Corner Half	F20065-T	24'	4	Clear	\$286.16
				Bronze	\$275.00
				2-Coat Kynar	\$374.33
				Powder Coat	N/A
 4-1/2" Left Corner Half	F20060-T	24'	4	Clear	\$284.55
				Bronze	\$345.11
				2-Coat Kynar	\$357.63
				Powder Coat	N/A



DRAFT

2" x 4-1/2" Thermally Broken Flush Glaze Frames with Screw Spline for 1" Glass

www.americanprod.com Email: bids@americanprod.com

Phone: 813-925-0144 Fax: 813-925-1414



RECEPTORS

DESCRIPTION	PART NUMBER	FOOT / UNIT	UNITS / PACKAGE	FINISH	LIST PRICE / UNIT
 Head Receptor With Gasket	F20085-T	24'	4	Clear	Quote
				Bronze	Quote
				2-Coat Kynar	Quote
				Powder Coat	N/A
 Head Receptor Face With Gasket	F20090	24'	4	Clear	Quote
				Bronze	Quote
				2-Coat Kynar	Quote
				Powder Coat	N/A



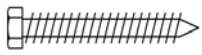

GASKET

 Gasket for 1" Glass	FAPI-129T	250'	1	Black	Quote

FASTENERS

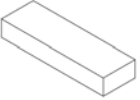
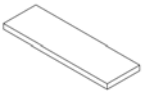
 Screw Spline Screws #12 x 1-1/4"	FA0001	Ea	100		\$.06
 Shear Block Screws #10 x 1-19/32"	FA0002	Ea	100		\$.11
 Shear Block Screws #10 x 9/16"	FA0003	Ea	100		\$.10

ACCESSORIES

 1" Setting Block - 5/8" x 1-1/4" x 4"	G32012	Ea	1		\$.98
 1" Setting Block - 3/16" x 1-1/4" x 4"	G32016	Ea	1		\$.70
 Shear Block Head / Sill	FA01868	24'	1		\$68.32
 Water Diverter	F20100	Ea	1		\$.60
 4" Flat Filler	F20045T-4	4"	4	Clear	\$2.14
				Bronze	\$1.79
				2-Coat Kynar	\$1.91
				Powder Coat	\$1.93



NOTES

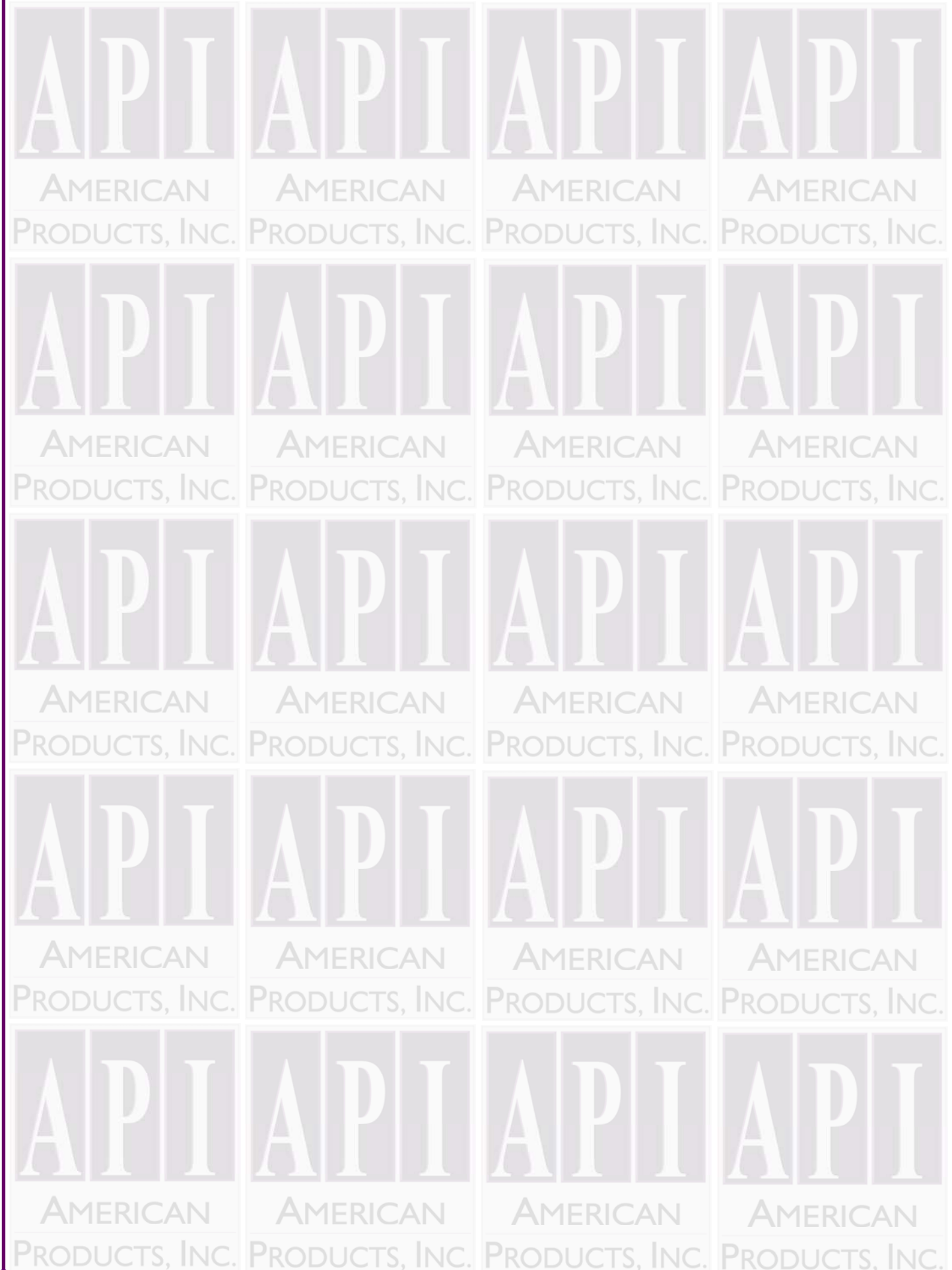

www.americanprod.com Email: bids@americanprod.com

Phone: 813-925-0144 Fax: 813-925-1414

Phone: 813-925-0144



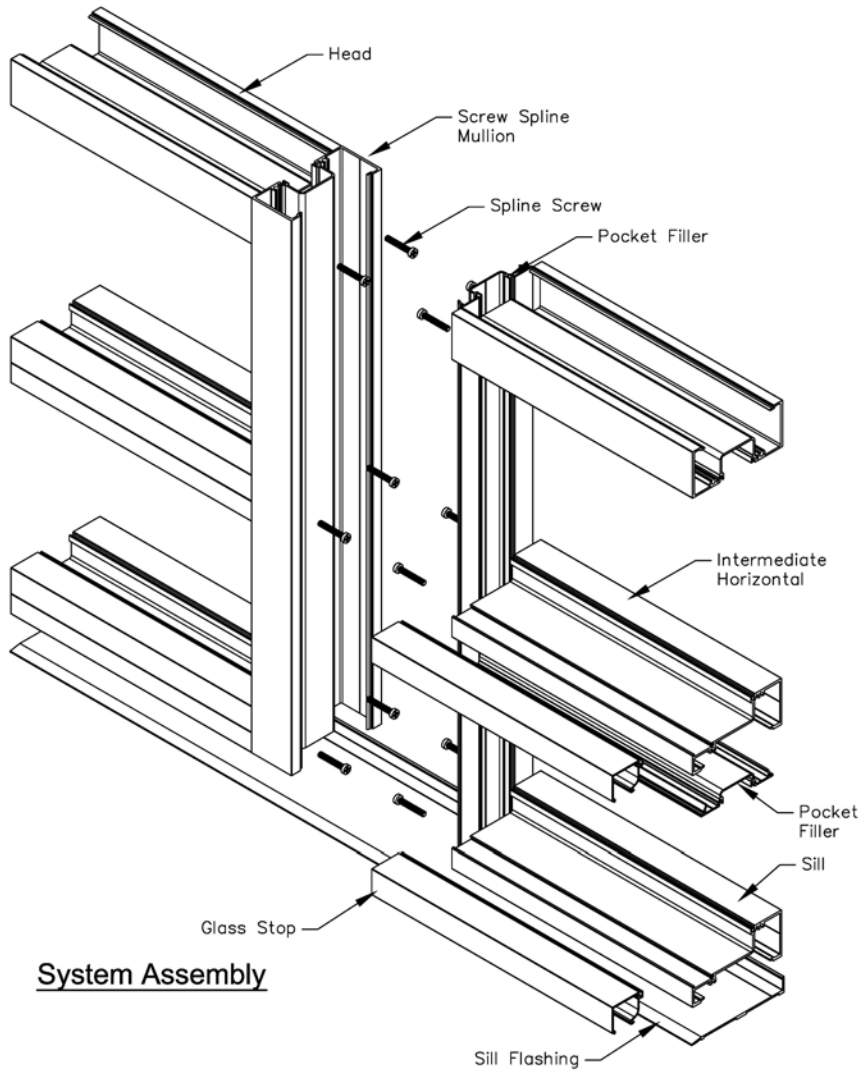

1/2" Screw Spline Flush Glaze Stops Up

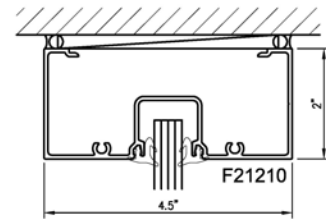

Head/Jamb Section

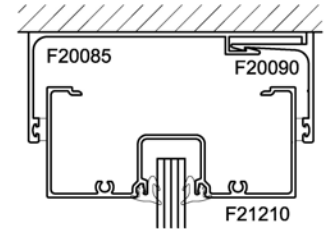

Head Receptor Section

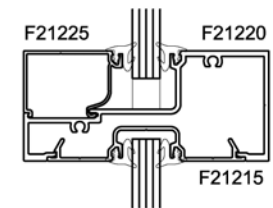

Intermediate Horizontal Section

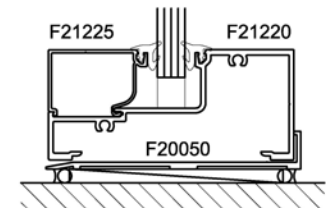

Sill Section

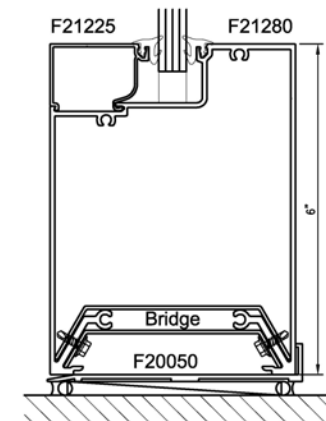

6" Sill Section

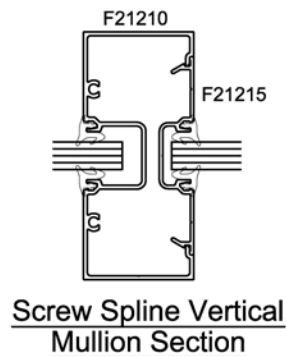

www.americanprod.com Email: bids@americanprod.com

Phone: 813-925-1414 Fax: 813-925-1414

Phone: 813-925-0144

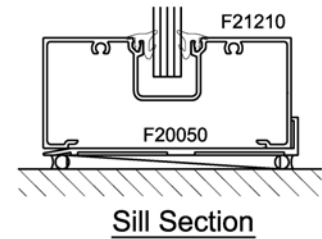
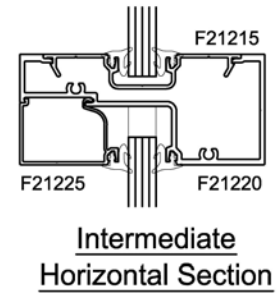
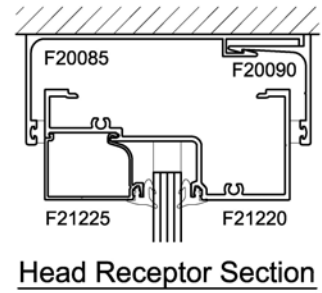
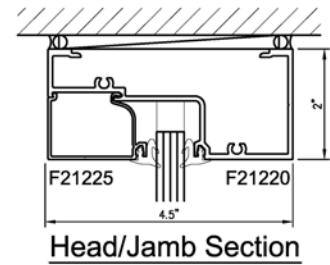
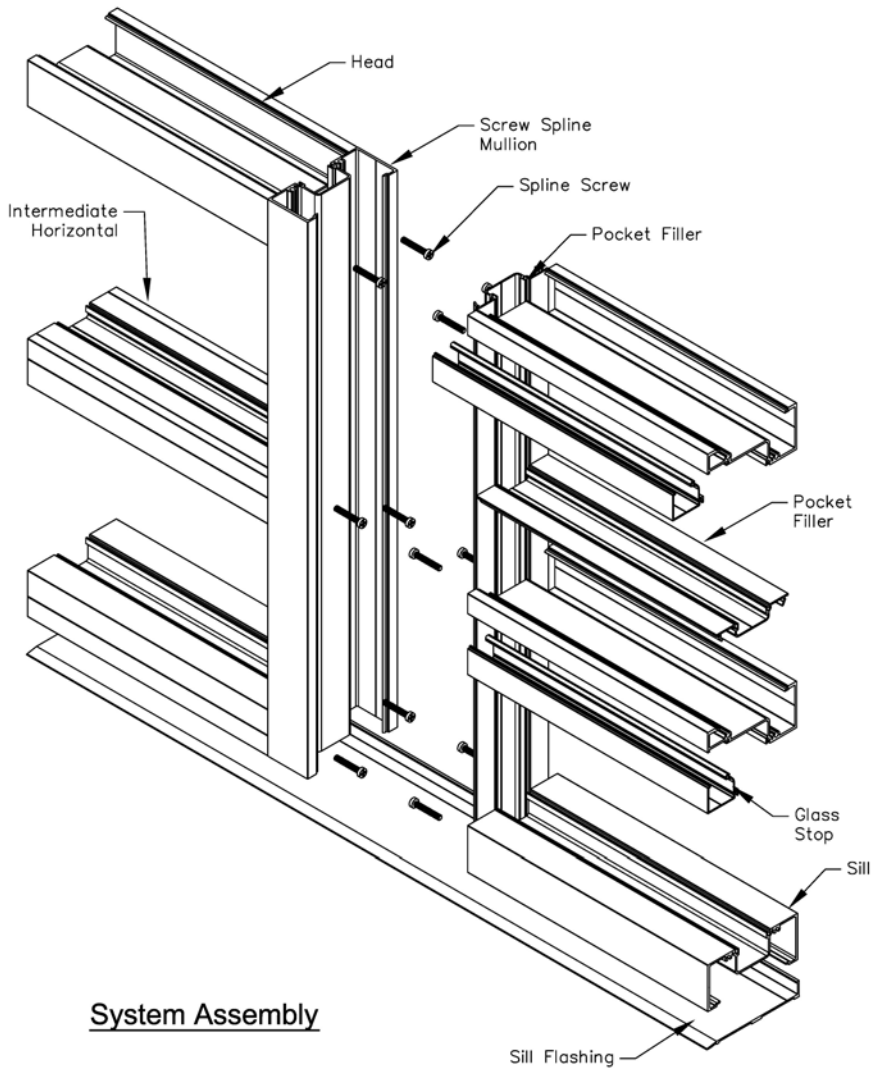

**1/2" Screw Spline
Flush Glaze
Stops Down**

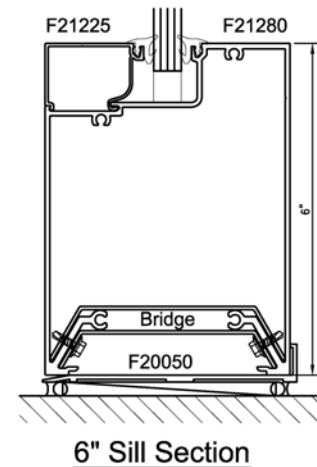
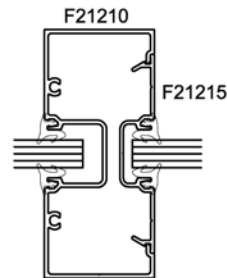

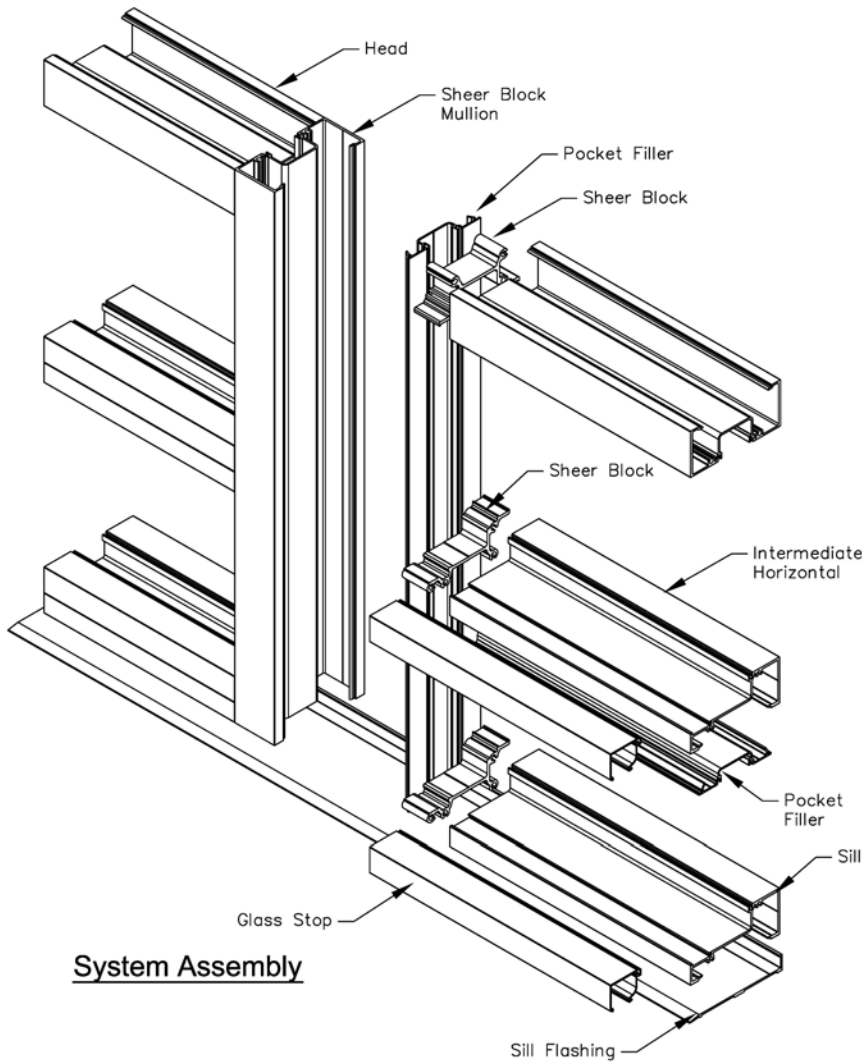

System Assembly

**1/2" Shear Block
 Flush Glaze
 Stops Up**

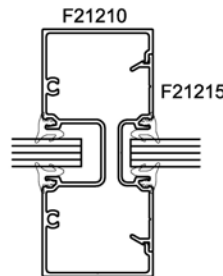

**Screw Spline Vertical
 Mullion Section**

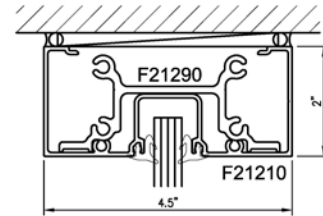

Head/Jamb Section

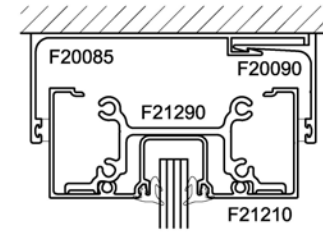

Head Receptor Section

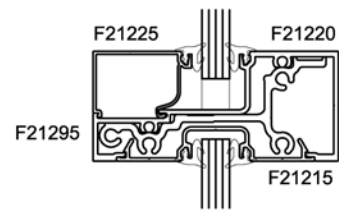

**Intermediate
 Horizontal Section**

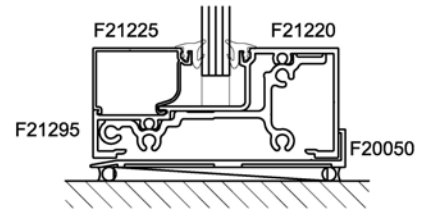

Sill Section

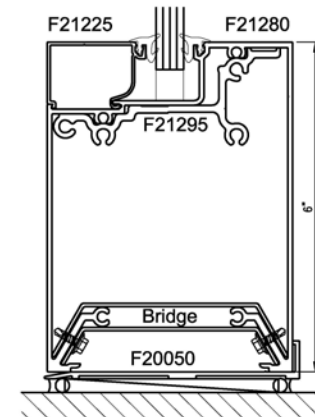

6" Sill Section

www.americanprod.com Email: bids@americanprod.com

Phone: 813-925-0144

Fax: 813-925-1414

www.americanprod.com Email: bids@americanprod.com

Fax: 813-925-1414

Phone: 813-925-0144

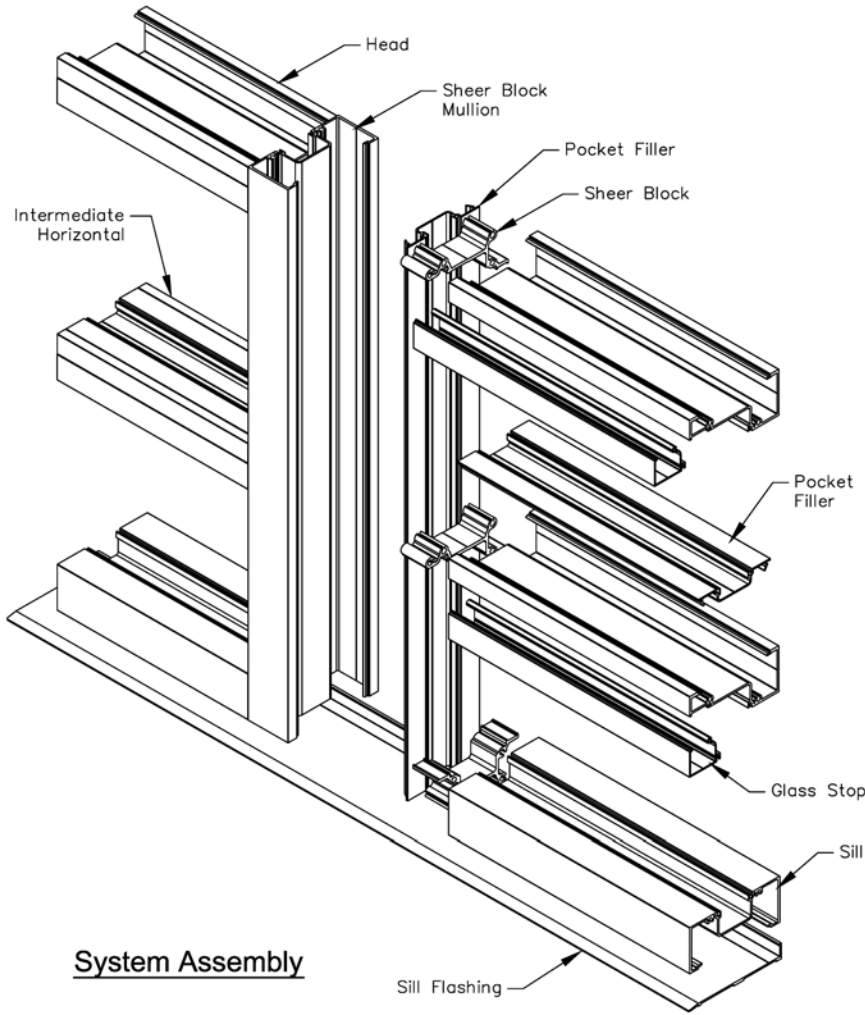

System Assembly

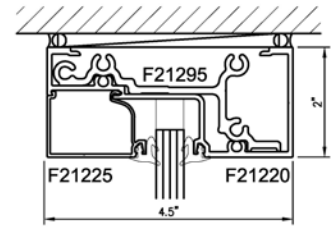

Head/Jamb Section

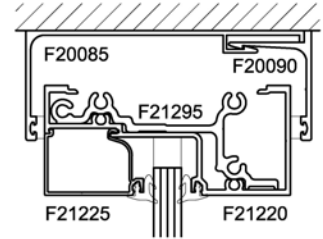

Head Receptor Section

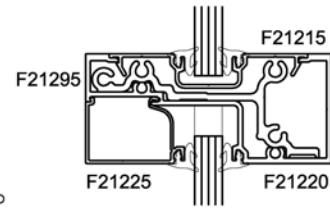

Intermediate Horizontal Section

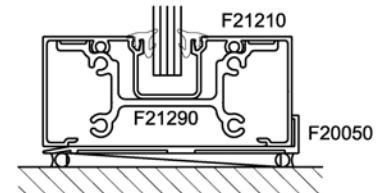

Sill Section

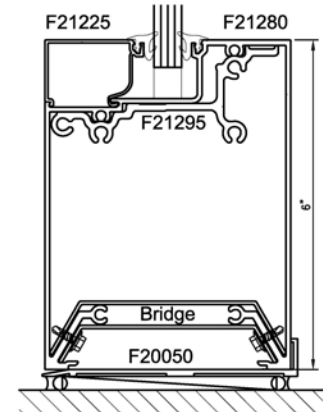

6" Sill Section

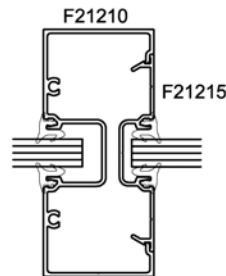

Screw Spline Vertical Mullion Section



1/2" Shear Block
Flush Glaze
Stops Down



FRAMING MEMBERS

DESCRIPTION	PART NUMBER	FOOT / UNIT	UNITS / PACKAGE	FINISH	LIST PRICE / UNIT
 Head / Jamb	F21210	24'	4	Clear	\$175.00
				Bronze	\$198.41
				2-Coat Kynar	\$198.00
				Powder Coat	\$199.81
 Stop	F21225	24'	4	Clear	\$51.07
				Bronze	\$65.00
				2-Coat Kynar	\$69.52
				Powder Coat	\$73.47
 Open Back Sill / Horizontal	F21220	24'	4	Clear	\$157.05
				Bronze	\$185.58
				2-Coat Kynar	\$195.00
				Powder Coat	\$183.93
 Pocket Filler	F21215	24'	4	Clear	\$80.00
				Bronze	\$85.76
				2-Coat Kynar	\$84.48
				Powder Coat	\$94.25
 Sill Flashing	F20050	24'	4	Clear	\$95.00
				Bronze	\$105.00
				2-Coat Kynar	\$110.00
				Powder Coat	\$87.95

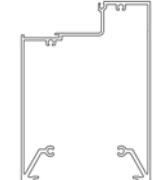
TALL SIDELITE BASE

 6" Sidelite Base	F21280	24'	4	Clear	\$480.88
				Bronze	\$565.00
				2-Coat Kynar	\$585.00
				Powder Coat	\$575.00
 Bridge (For Bay Over 48")	F20080ULB	12'	4	Clear	\$201.60

CORNERS

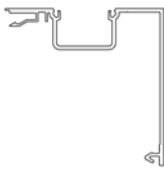
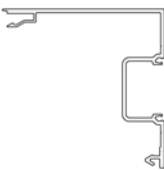
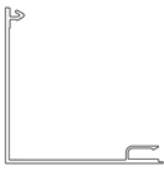

 One Pocket Corner Half Left	F21260	24'	4	Clear	\$213.56
				Bronze	\$249.93
				2-Coat Kynar	\$273.03
				Powder Coat	\$249.40
 One Pocket Corner Half Right	F21265	24'	4	Clear	\$213.56
				Bronze	\$249.93
				2-Coat Kynar	\$273.03
				Powder Coat	\$249.96
 4-1/2" No Pocket Corner Half	F20075	24'	4	Clear	\$157.64
				Bronze	\$205.16
				2-Coat Kynar	\$204.23
				Powder Coat	\$197.96





www.americanprod.com Email: bids@americanprod.com

Phone: 813-925-0144 Fax: 813-925-1414

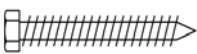

GASKET

DESCRIPTION	PART NUMBER	FOOT / UNIT	UNITS / PACKAGE	FINISH	LIST PRICE / UNIT
 Gasket	FAPI-129	250'	1	Black	\$43.40
 Gasket	FAPI-177	250'	1	Black	\$50.76
 Gasket	FAPI-176	250'	1	Black	\$77.00

FASTENERS

 Screw Spline Screws #12 x 1-1/8"	FA0001	Ea	100		\$.06
 Shear Block Screws #10 x 1-19/32"	FA0002	Ea	100		\$.11
 Shear Block Screws #10 x 9/16"	FA0003	Ea	100		\$.10

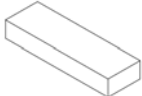
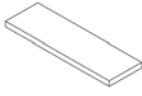
ACCESSORIES

 1" Setting Block - 5/8" x 1-1/4" x 4"	G32012	Ea	1		\$.98
 1" Setting Block - 3/16" x 1-1/4" x 4"	G32016	Ea	1		\$.70
 Shear Block Sill / Intermediate	FA01868	Ea	1		\$68.32
 Shear Block Head / Jamb	FA01848	Ea	1		\$75.38

GLAZING GASKET CHART		
Infill	Vinyl	Adaptor
3/8"	FAPI-177	N/A
3/4"	FAPI-176	N/A
5/8"	FAPI-176	N/A
1/2"	FAPI-129	N/A
1/4"	FAPI-176	F50005

www.americanprod.com Email: bids@americanprod.com

Phone: 813-925-0144

Fax: 813-925-1414

